

Catalog #	Type	Type
Project		
Comments		Date
Prepared by		

Description

Choose the type of light you need by selecting your ideal color temperature during the installation of this LED suspension light fixture. This selectable fixture features a switch that can adjust the color temperatures of the light the fixture emits.

Designed to make a statement, this minimalistic linear LED connects with other 3 ft., 4 ft., or 5 ft. linear pendants using a line joiner to create a continuous run of light. Its deep regressed lens evenly distributes glare-free light that is easy on the eyes for longer day-to-day use.

Replace existing fluorescent strip fixtures with this more efficient color selectable LED suspension light fixture to reduce energy and maintenance costs.

Product Specification	
Mode	IL-178 Up/Down
CCT	3000K, 4000K, 6000K
Wattages	30W, 40W
Lumens	2850lm, 35344lm
Input Voltage	100-277V
Power Factor	>0.95
Dimming	Non-Dimmable/ 0- 10V
CRI	≥ 80, ≥ 90
Finishes	White, Black, Grey, Custom
Beam angle	98°
Dimensions	L: 3ft,4ft,5ft, W: 1.7" x H: 1.6"
Application	Suspended
Lifespan	50,000+ Hours
Certification	ETL Listed
Warranty	5 years

Certification Information



3000K	4000K	6000K
-------	-------	-------

Dimensions

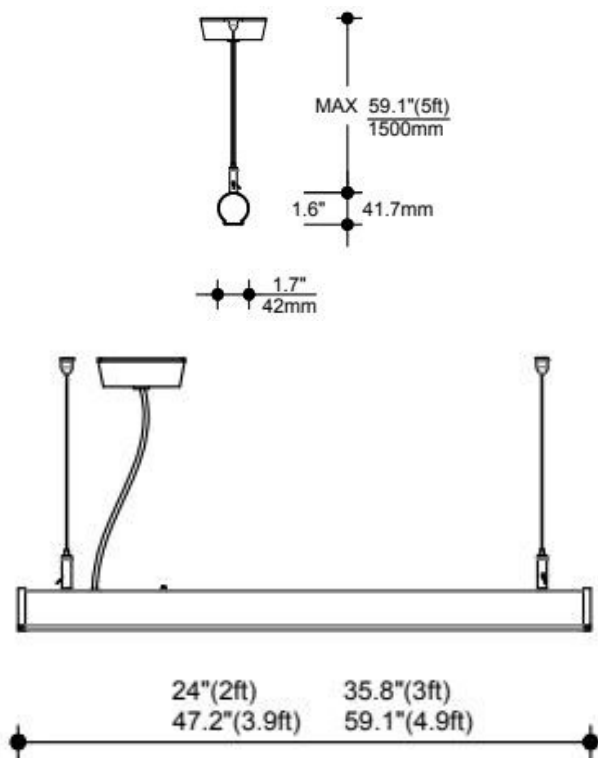

ORDERING INFORMATION

ITEM NUMBER	Lengths	Wattages/ft	Input Voltage	CCT	Dimming	Finish
IL-178 Up/Down	3ft	30W	100-277V	3000K	Non Dimmable	White
	4ft	40W		4000K	0 -10V (integrated)	Black
	5ft	40W		6000K	DALI (integrated)	Grey
					TRIAC (integrated)	Custom

LINKABLE ACCESSORIES

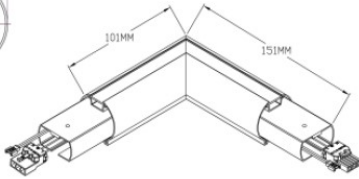
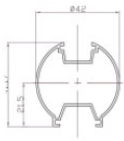

Easy fasten buckle,T-connection

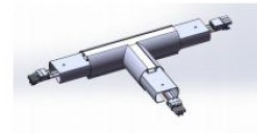
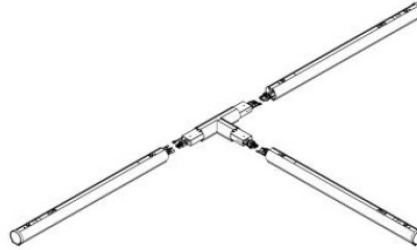
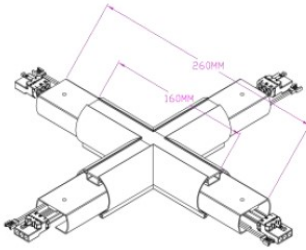
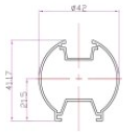

Easy fasten buckle,cross connection

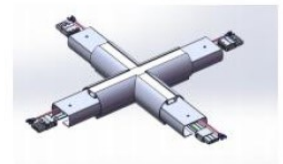
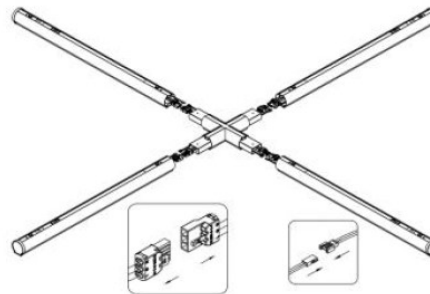
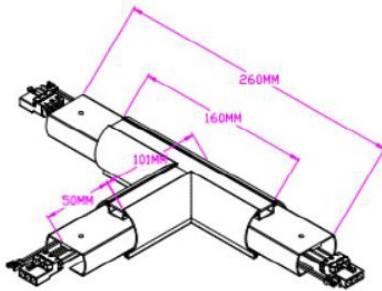
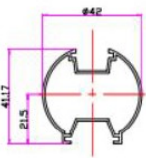

Optional Layouts

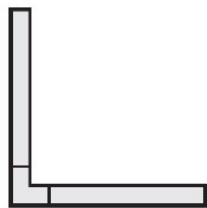

'L' Pattern

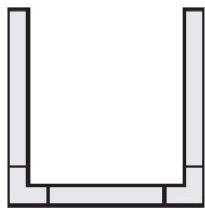

'U' Pattern

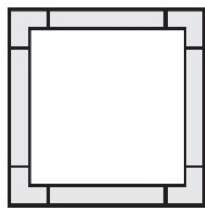

'□' Pattern

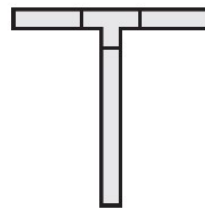

'T' Pattern

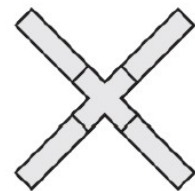

'X' Pattern